



# KitchenAid

## TOASTERS

### 5KMT221, 5KMT421 PRODUCT GUIDE

[Get Original](#)



# PARTS AND FEATURES

---

## TOASTER PARTS

---

### 2-Slice Model

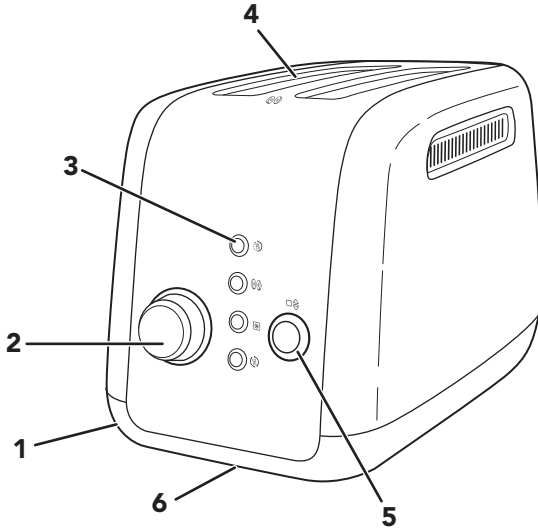

- |                                     |   |
|-------------------------------------|---|
| 1. Removable Crumb Tray (not shown) | 4. Extra-Wide Slots with Automatic Self-Centering Racks |
| 2. Shade Control Dial (7 settings)  | 5. Toast/Cancel button                                  |
| 3. Special Toasting Functions       | 6. Under Base Cord Wrap (not shown)                     |

### 4-Slice Model

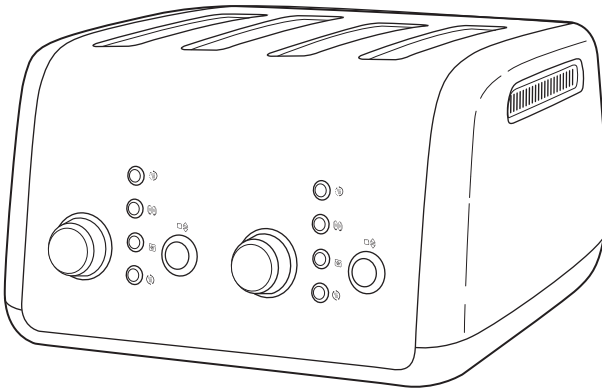

Same great parts and features as 2-Slice Model, with **two independent control panels** that allow you to select different settings for each pair of slots.

#### Optional accessories

A Bun Warmer (model [5KTBW22](#)) and a Sandwich Rack (model [5KTSR1](#)) can be purchased as optional accessories to be used with the 2-slice and 4-slice Toasters.

## CONTROL PANEL FEATURES

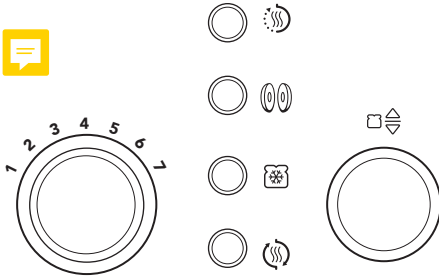

### Shade Control Dial

Features a rotating knob for precision control (7 settings). Turn knob to the right for darker or to the left for lighter toasting.

### Keep Warm Function (🌀)

Select to Keep Warm slices that have just been toasted (up to 3 minutes). The End-of-Cycle signal will beep and the toaster will shut off and raise the slices.

### Bagel Function (🥯)

Designed to toast bagels, crumpets, muffins, buns or any other round breads that you wish to cut in half and toast only on one side. The heating elements will adjust to nicely toast the inside of a cut bagel (or other round bread) while gently warming the outer surface.

### Frozen Function (❄️)

Defrosts and toasts frozen bread.

### Reheat Function (🔥)

Quickly reheats slices in less than a minute.

### Toast/Cancel button (🍞↕️)

Lowest the slices and starts the toasting cycle/cancels the cycle and lifts the slices. A ring of light around the button illuminates when the heaters are actively toasting.

## TOASTER FEATURES

### Extra-wide Slots

Handles thick bread slices, buns or bagels easily.

### Self-centering Bread Racks

Centers thick or thin breads perfectly for even toasting.

### Removable Crumb Tray(s)

Durable steel tray (two side-by-side trays on 4-slot model) can be washed in the top rack of a dishwasher.

### Under Base Cord Wrap

Keeps extra cord out of sight and out of the way.

### Stylish Exterior

Stainless steel and painted steel surfaces are constructed for durability and style.

### Steel Interior

Durable and deep toasting cavity helps to ensure even browning.

# PRODUCT SAFETY

## Your safety and the safety of others are very important.

We have provided many important safety messages in this manual and on your appliance. Always read and obey all safety messages.



This is the safety alert symbol.

This symbol alerts you to potential hazards that can kill or hurt you and others.

All safety messages will follow the safety alert symbol and either the word "DANGER" or "WARNING." These words mean:

 **DANGER**

**You can be killed or seriously injured if you don't immediately follow instructions.**

 **WARNING**

**You can be killed or seriously injured if you don't follow instructions.**

All safety messages will tell you what the potential hazard is, tell you how to reduce the chance of injury, and tell you what can happen if the instructions are not followed.

## IMPORTANT SAFEGUARDS

**When using electrical appliances, basic safety precautions should always be followed, including the following:**

1. Read all instructions. Misuse of appliance may result in personal injury.
2. Do not touch hot surfaces. Use handles or knobs.
3. The appliance must not be immersed. To protect against electrical shock do not immerse cord, plugs or appliance in water or other liquid.
4. This appliance is not intended for use by persons (including children) with reduced physical, sensory or mental capabilities, or lack of experience and knowledge, unless they have been given supervision or instruction concerning use of the appliance by a person responsible for their safety. Children should be supervised to ensure that they do not play with the appliance.
5. European Union Only: This appliance shall not be used by children. Keep the appliance and its cord out of reach of children.

- 6.** Close supervision is necessary when any appliance is used by or near children.
- 7.** European Union Only: Appliances can be used by persons with reduced physical, sensory, or mental capabilities or lack of experience and knowledge if they have been given supervision or instruction concerning use of the appliance in a safe way and understand the hazards involved. Children shall not play with the appliance.
- 8.** Children should be supervised to ensure that they do not play with the appliance.
- 9.** If the Supply Cord is damaged, it must be replaced by the manufacturer, its service agent or similarly qualified persons in order to avoid a hazard.
- 10.** Turn the appliance OFF (0), then unplug from the outlet when not in use, before assembling or disassembling parts and before cleaning. To unplug, grasp the plug and pull from the outlet. Never pull from the power cord.
- 11.** Unplug from outlet when not in use and before cleaning. Allow to cool before putting on or taking off parts.
- 12.** Do not operate any appliance with a damaged cord or plug, or after the appliance malfunctions, or is dropped or damaged in any manner. Return appliance to the nearest Authorised Service Facility for examination, repair, or electrical or mechanical adjustment.
- 13.** The use of accessories/attachments not recommended by the appliance manufacturer may result in fire, electric shock or injury to persons.
- 14.** Do not use outdoors.
- 15.** Do not let cord hang over edge of table or counter, or touch hot surfaces.
- 16.** Do not place on or near a hot gas or electric burner, or in a heated oven.
- 17.** Never leave the appliance unattended while it is in operation.
- 18.** Always attach plug to appliance first, then plug cord into the wall outlet. To disconnect, turn any control to OFF (0) then remove plug from wall outlet.
- 19.** When heating toaster pastries, always use the lightest toast colour setting.
- 20.** Do not use appliance for other than intended use.

21. Oversize foods, metal foil packages, or utensils must not be inserted in the Toaster as they may involve a risk of fire or electric shock.
22. A fire may occur if the Toaster is covered with or touching flammable material, including curtains, draperies, walls and the like, when in operation.
23. Do not attempt to dislodge food when the Toaster is plugged in.
24. The appliance is not intended to be operated by means of an external timer or separate remote-control system.
25. The bread may burn, therefore do not use the Toaster near or below combustible material, such as curtains.
26. Allow the appliance to cool completely before putting on or taking off parts, and before cleaning the appliance.
27. Refer to the “Care and Cleaning” section for instructions on cleaning the surfaces in contact with food.
28. This Appliance is intended to be used in household and similar applications such as:
  - staff kitchen areas in shops, offices and other working environments;
  - farmhouses;
  - by clients in hotels, motels and other residential type environments;
  - bed and breakfast type environments.

## **SAVE THESE INSTRUCTIONS**

For complete details on product information, instructions and videos, including Guarantee information, visit [www.KitchenAid.co.uk](http://www.KitchenAid.co.uk) or [www.KitchenAid.eu](http://www.KitchenAid.eu). This may save you the cost of a service call. To receive a free printed copy of the information online, call **00 800 381 040 26**.

## ELECTRICAL REQUIREMENTS

### **⚠ WARNING**



#### **Electrical Shock Hazard**

**Plug into an earthed outlet.**

**Do not remove earth prong.**

**Do not use an adapter.**

**Do not use an extension cord.**

**Failure to follow these instructions can result in death, fire, or electrical shock.**

**Voltage:** 220-240 V

**Frequency:** 50/60 Hz

**Wattage:** 1100 W for the 2-slice model 5KMT221

1800 W for the 4-slice model 5KMT421

**NOTE:** If the power cord is damaged, it must be replaced by the manufacturer or its service agent in order to avoid a hazard. Do not use an extension cord. If the power supply cord is too short, have a qualified electrician or service technician install an outlet near the appliance.

## PRODUCT USAGE

### **BEFORE FIRST USE**

Before using your Toaster, check the Extra-Wide Slots and remove any packing or printed material that might have fallen inside during shipping or handling. Do not probe inside the Toaster with a metal object.

You may see light smoke the first time you use the Toaster. This is normal. The smoke is harmless and will soon disappear.

Shorten cord, if necessary, by wrapping cord under the base. The Toaster's feet are tall enough to allow the cord to exit from under any side of the Toaster.

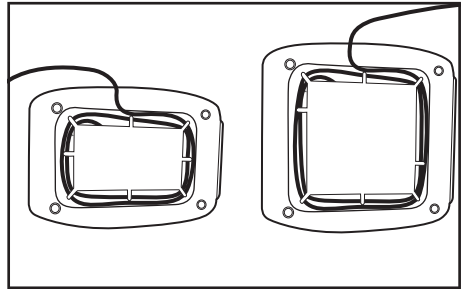

## USING THE TOASTER

### **⚠ WARNING**



#### **Electrical Shock Hazard**

**Plug into an earthed outlet.**

**Do not remove earth prong.**

**Do not use an adapter.**

**Do not use an extension cord.**

**Failure to follow these instructions can result in death, fire, or electrical shock.**

1. Plug the Toaster cord into an earthed outlet.

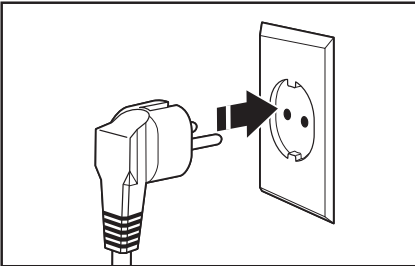

2. Insert bread or other food to be toasted in slot.

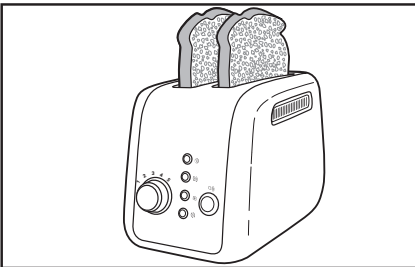

**NOTE:** For even toasting on 2-Slice Model, toast only one bread type and thickness at a time. For 4-Slice Model, with Dual Independent Controls, if toasting of two different breads is desired, be sure to toast only one bread type in each pair of slots.

3. Turn the Shade Control Dial to select the degree of darkness you want. Turn it to the right for darker toasting or to the left for lighter.

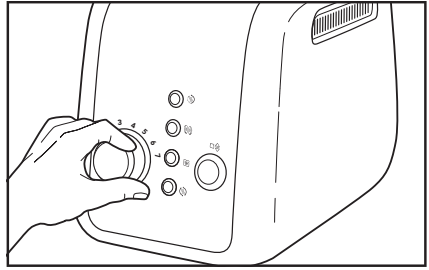

**NOTE:** Different types of bread and their moisture levels may require different shade settings. For example, dry bread will brown more rapidly than moist bread and will require a lighter setting.

4. (Optional) Press desired Special Toasting Function button. See the "Using the Special Toasting Functions" section for more information.

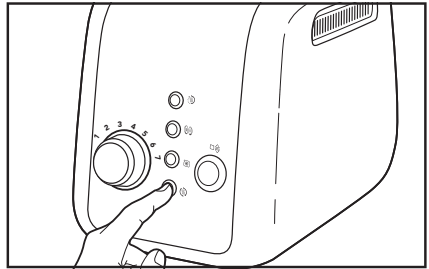

5. Press the TOAST/CANCEL (☐⏻) button to begin toasting. The Centering Racks will adjust automatically to hold food upright. When toasting is complete, the End-of-Cycle signal will beep, the Toaster will shut off and raise the toast.

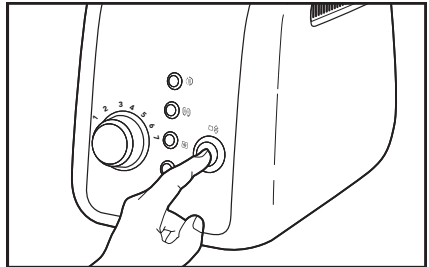



6. To cancel toasting at any time, press TOAST/CANCEL (☐☞) button again. The Toaster will shut off and raise the toast.

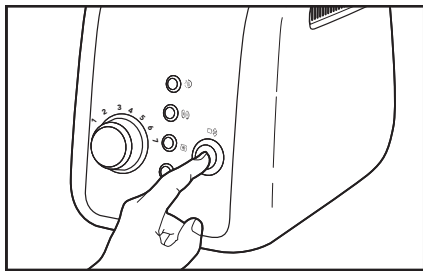

## USING THE SPECIAL TOASTING FUNCTIONS

Either before, or just after pressing TOAST/CANCEL (☐☞) button to begin toasting, you can select the Special Toasting Functions by pressing the appropriate button. After a toasting cycle is complete, all functions will be cleared.

### Keep Warm function (☺)

1. Make sure the just toasted food is still in the slot, or place it back in the Toaster.

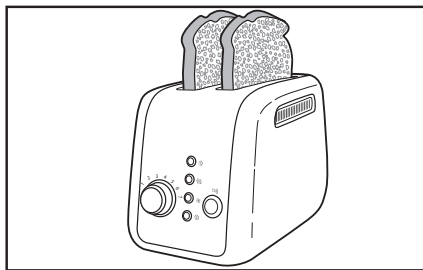

2. Press the KEEP WARM (☺) button.

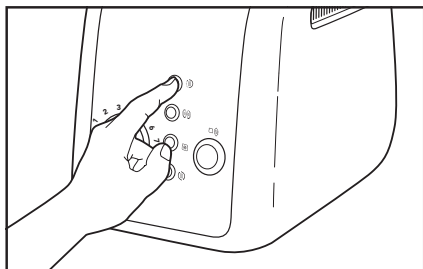

**NOTE:** No Shade adjustment is necessary – the Keep Warm (☺) function overrides whatever Shade level you have set.

3. Press the TOAST/CANCEL (☐☞) button to begin the warming cycle.

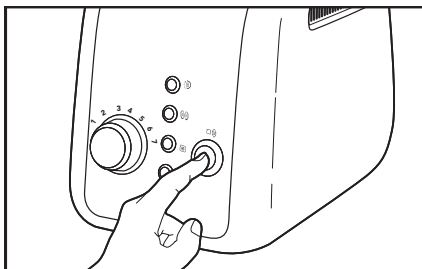

4. To cancel warming at any time, press TOAST/CANCEL (☐☞) button again. The Toaster will shut off after 3 minutes and raise the toast.

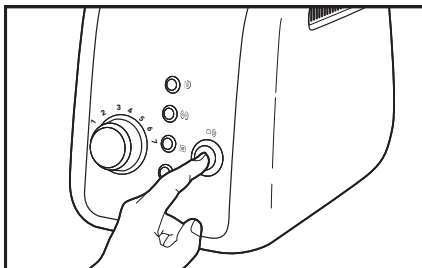

### Bagel function (☉☉)

1. Insert the halves of bagel (or of other round breads) with the flat side facing in, as shown.

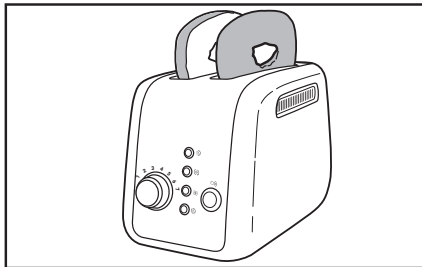

2. Set the Shade Control to the desired level.

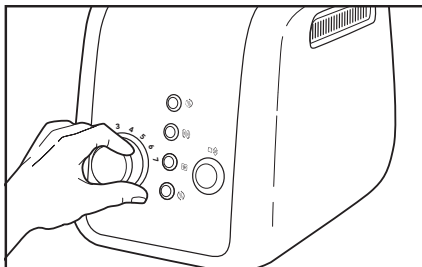

3. Press the BAGEL (☉) button.

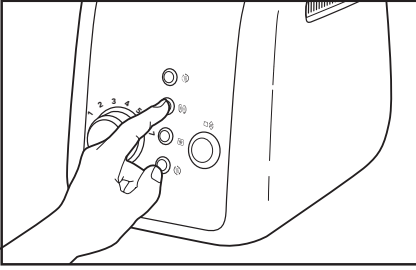

4. Press the TOAST/CANCEL (☐) button to begin toasting.

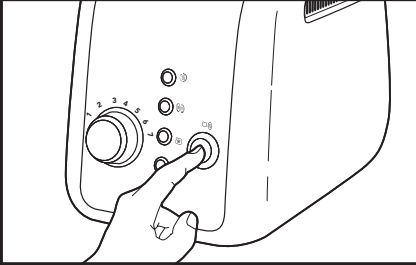

5. To cancel toasting at any time, press the TOAST/CANCEL (☐) button again. The Toaster will shut off and raise the bagel.

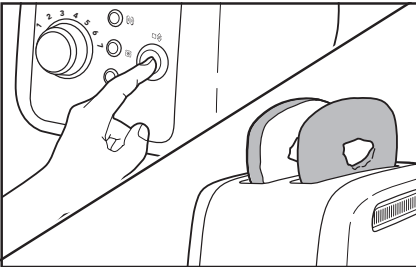

### Frozen function (☼)

1. Insert the frozen item into bread slot. Use the Frozen function for frozen foods only.

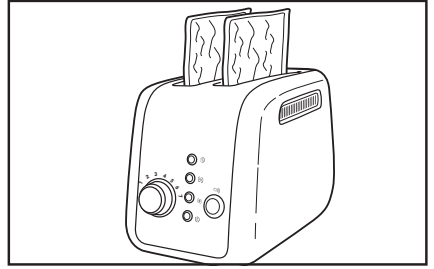

2. Set the Shade Control to the desired level.

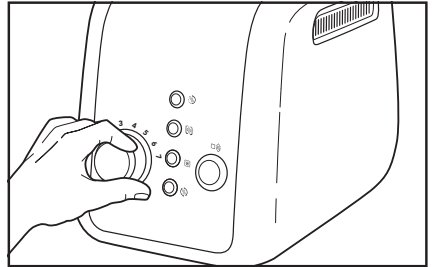

3. Press the FROZEN (☼) button.

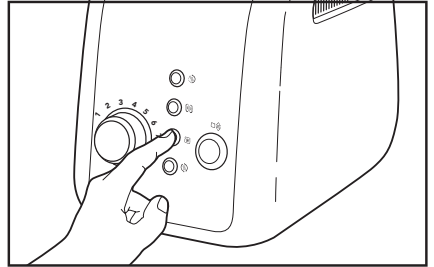

4. Press the TOAST/CANCEL (☐) button to begin toasting.

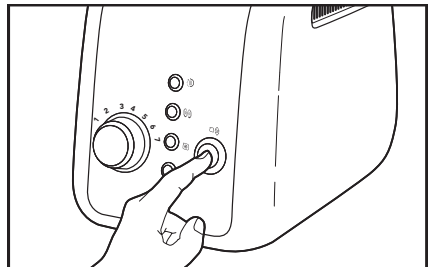

5. To cancel toasting at any time, press the TOAST/CANCEL (☐☞) button again. The Toaster will shut off and raise the toasted item.

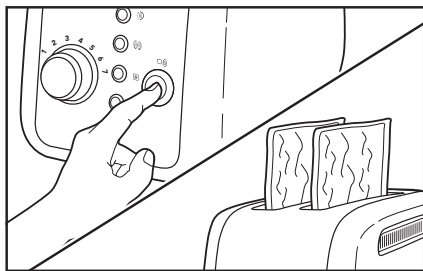

### Reheat function (☺)

1. Insert the food into Toaster slot. Do not place food with butter or any other topping in the Toaster. Use the Reheat function for dry foods only.

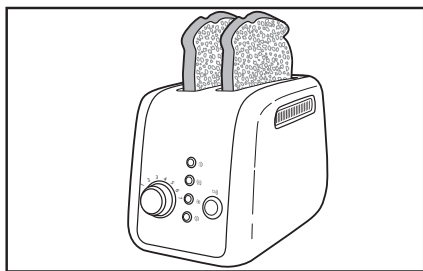

2. Press the REHEAT button (☺).

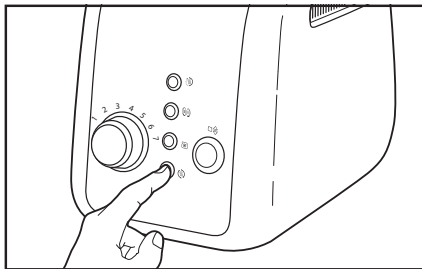

**NOTE:** No Shade adjustment is necessary – the Reheat function overrides whatever Shade level you have set.

3. Press the TOAST/CANCEL (☐☞) button to begin reheating.

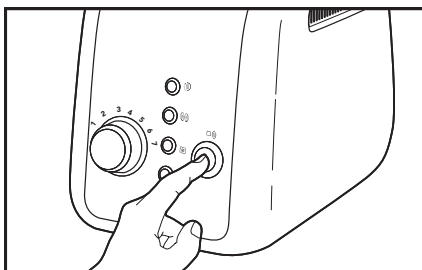

4. To cancel reheating at any time, press the TOAST/CANCEL (☐☞) button again. The Toaster will shut off and raise the toast.

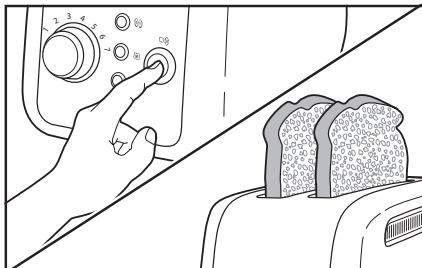

# CARE AND CLEANING

**IMPORTANT:** Allow the appliance to cool completely before putting on or taking off parts, and before cleaning the appliance.

1. Unplug the Toaster and let it cool before cleaning.

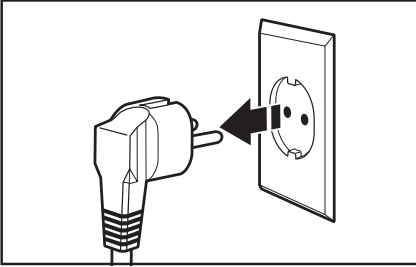

2. Press and release the center of the Removable Crumb Tray then slide it out. Shake the crumbs into a waste container. It is recommended that the Crumb Tray be emptied after each use. The Crumb Tray can be washed in the top rack of a dishwasher.

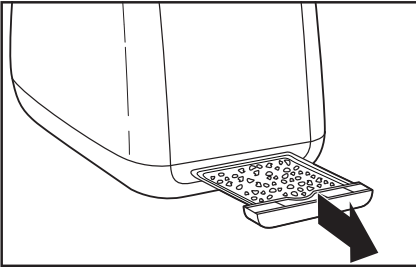

**IMPORTANT:** The tray will be hot immediately following a toasting cycle.

3. Wipe Toaster with a soft, damp cotton cloth. Do not use paper towels, abrasive cleansers or liquid cleaning products. Do not immerse Toaster in water.

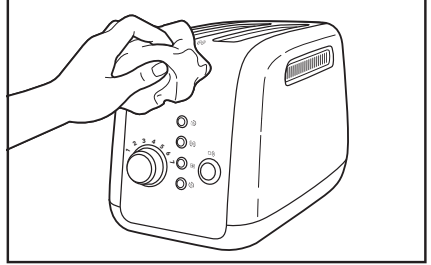

4. Return Crumb Tray to Toaster. Press it in firmly until it clicks into position. Do not use the Toaster without the Crumb Tray in proper position.

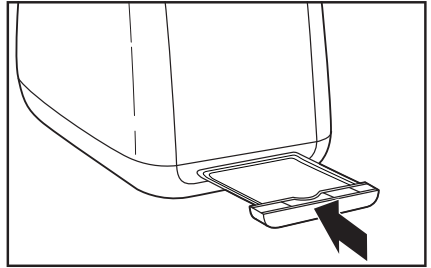

**NOTE:** If grease or oil splatters on the Toaster, wipe splatters away immediately using a soft, damp cotton cloth.

**NOTE:** KitchenAid does not recommend the use of a Toaster cover.

## **WARNING**

### Electrical Shock Hazard



**Plug into an earthed outlet.**

**Do not remove earth prong.**

**Do not use an adapter.**

**Do not use an extension cord.**

**Failure to follow these instructions can result in death, fire, or electrical shock.**

PROBLEM	SOLUTION
If your Toaster should fail to operate, check the following:	<ol style="list-style-type: none"> <li>1. Check that the Toaster is plugged into a proper electrical outlet. If it is, unplug the Toaster.</li> <li>2. Plug in Toaster</li> <li>3. If the Toaster still does not work, check the household fuse or circuit breaker.</li> </ol>
If the problem cannot be corrected:	See the "Terms of KitchenAid Guarantee ("Guarantee")" sections.

## ELECTRICAL EQUIPMENT WASTE DISPOSAL

### DISPOSAL OF PACKING MATERIAL

The packing material is recyclable and is marked with the recycle symbol . The various parts of the packing must therefore be disposed of responsibly and in full compliance with local authority regulations governing waste disposal.

### RECYCLING THE PRODUCT

- This appliance is marked in compliance with law in the EU and UK covering, Waste Electrical and Electronic Equipment (WEEE).
- By ensuring this product is disposed of correctly, you will help prevent potential negative consequences for the environment and human health, which could otherwise be caused by inappropriate waste handling of this product.
- The symbol  on the product or on the accompanying documentation indicates that it should not be treated as domestic waste but must be taken to an appropriate collection centre for the recycling of electrical and electronic equipment.

For more detailed information about treatment, recovery and recycling of this product, please contact your local city office, your household waste disposal service or the shop where you purchased the product.

# DECLARATION OF CONFORMITY

---

## FOR UNITED KINGDOM

---

This appliance has been designed, constructed and distributed in compliance with the safety requirements of UK Legislation: Electrical Equipment (Safety) Regulations 2016, Electromagnetic Compatibility Regulations 2016. The Ecodesign for Energy-Related Products and Energy Information (Amendment) (EU Exit) Regulations 2019. The Restriction of the Use of Certain Hazardous Substances in Electrical and Electronic Equipment Regulations 2012.

## FOR EUROPEAN UNION

---

This appliance has been designed, constructed, and distributed in compliance with the safety requirements of EC Directives: Low Voltage Directive 2014/35/EU, Electromagnetic Compatibility Directive 2014/30/EU, Ecodesign Directive 2009/125/EC, RoHS Directive 2011/65/EU and following amendments.

# TERMS OF KITCHENAID GUARANTEE ("GUARANTEE")

---

### Covering U.K. - Ireland - South Africa - UAE

KitchenAid Europa, Inc., Nijverheidslaan 3, Box 5, 1853 Strombeek-Bever, Belgium ("Guarantor") grants the end-customer, who is a consumer, a Guarantee pursuant to the following terms.

#### FOR U.K.:

The Guarantee applies in addition to and does not limit or affect the statutory warranty rights of the end-customer against the seller of the product. In summary, the Consumer Rights Act 2015 says products must be as described, fit for purpose and of satisfactory quality. During the expected lifespan of your product your legal rights entitle you to the following:

- Up to 30 days: if your product is faulty, then you can get an immediate refund.
- Up to six months: if your product can't be repaired or replaced, then you're entitled to a full refund, in most cases.
- Up to six years: if your product does not last a reasonable length of time you may be entitled to some money back.

These rights are subject to certain exceptions. For detailed information please visit the Citizens Advice website [www.adviceguide.org.uk](http://www.adviceguide.org.uk) or call **03454 04 05 06**.

#### FOR IRELAND:

The Guarantee applies in addition to and does not limit or affect the statutory warranty rights of the end-customer against the seller of the product under the European Communities (Certain Aspects of the Sale of Consumer Goods and Associated Guarantees Regulations 2003 (S.I. No. 11/2003)) and other enactments governing the sale of consumer goods.

#### FOR SOUTH AFRICA:

The Guarantee applies in addition to and does not limit or affect the statutory warranty rights of the end-customer against the seller of the product. In summary, the Consumer Protection Act, 2008 says that products must be: (i) reasonably suitable for the purpose for which they are intended; (ii) in good working order, of good quality and free of any defects; (iii) useable and durable for a reasonable period of time, having regard to the use to which they would normally be put and to all the surrounding circumstances; and (iv) in compliance with any applicable standards or any other public regulations.

During the expected lifespan of your product and where the products are not purchased online, your legal rights will entitle you to the following:

- You will be entitled to a full refund, if you did not have the opportunity to examine the product before delivery and if you rejected delivery of the product on the basis that the type and quality of the product was not as reasonably expected or did not reasonably conform to the material specifications.
- Within 5 business days after delivery: you may rescind your purchase and request a refund, if your purchase resulted from direct marketing.
- Within 10 business days after delivery: you will be entitled to a full refund, if it is found that the product was unsuitable for a particular purpose specifically communicated to you by the Guarantor.
- Within 15 business days after delivery: you will be entitled to a refund if: (i) the product was not delivered to you; or (ii) if you returned the product to the Guarantor.
- Within 6 months after delivery: you will be entitled to a refund or a replacement product, if the product is defective or fails to operate in terms of its specifications.

Where you have purchased a product online your legal rights will be governed by the Electronic Communications and Transactions Act, 2002 and you will be entitled to the following:

- Within 7 days after conclusion of the transaction or after delivery: you may cancel your purchase without reason and without penalty.
- Within 30 days of the date of cancellation of the transaction: you will be entitled to receive a refund, if you have already made payment.
- You will only be liable for the direct costs of returning the product to the Guarantor.

#### FOR UAE:

The Guarantee applies in addition to and does not limit or affect the statutory warranty rights of the end-customer against the seller of the product.

#### 1. SCOPE AND TERMS OF THE GUARANTEE

- a) The Guarantor grants the Guarantee for the products mentioned under Section 1.b) which a consumer has purchased from a seller or a company of the KitchenAid-Group within the following countries: U.K., Ireland, or South Africa, or the United Arab Emirates (UAE).
- b) The Guarantee period depends on the purchased product and is as follows:
 

**Two Year full guarantee from date of purchase.**
- c) The Guarantee period commences on the date of purchase, i.e. the date on which a consumer purchased the product from a dealer or a company of the KitchenAid-Group.
- d) The Guarantee covers the defect-free nature of the product.
- e) The Guarantor shall provide the consumer with the following services under this Guarantee, at the choice of the Guarantor, if a defect occurs during the Guarantee period:
  - Repair of the defective product or product part, or
  - Replacement of the defective product or product part. If a product is no longer available, the Guarantor is entitled to exchange the product for a product of equal or higher value.
- f) If the consumer wishes to make a claim under the Guarantee, the consumer has to contact the country specific KitchenAid service centres or the Guarantor directly at KitchenAid Europa, Inc. Nijverheidslaan 3, Box 5, 1853 Strombeek-Bever, Belgium;

Email-Address U.K.: [CONSUMERCARE.UK@kitchenaid.eu](mailto:CONSUMERCARE.UK@kitchenaid.eu)

Email-Address IRELAND: [CONSUMERCARE.IE@kitchenaid.eu](mailto:CONSUMERCARE.IE@kitchenaid.eu)

Toll Free Number U.K. & IRELAND: **00 800 381 040 26**

#### FOR SOUTH-AFRICA:

##### Our local KitchenAid Distributor:

KitchenAid Africa  
PO Box 52102  
V&A Waterfront  
Cape Town  
8002

##### Contact our distributor:

Telephone: +27 21 555 0700

You can contact our Customer Service Centre for Small Domestic Appliances from 8.30 am to 1.00 pm and from 1.30 pm to 5.00 pm or write to us at the following address: [hello@kitchenaidafrica.com](mailto:hello@kitchenaidafrica.com)

#### FOR UAE:

##### AL GHANDI ELECTRONICS.

POST BOX NO. 9098,  
DUBAI, UNITED ARAB EMIRATES  
Toll free number: +971 4 2570007

- g) The costs of repair, including spare parts, and any postage costs (if applicable) for the delivery of a defect-free product or product part shall be borne by the Guarantor. The Guarantor shall also bear the postage costs for returning the defective product or product part if the Guarantor or the country specific KitchenAid customer service centre requested the return of the defective product or product part. However, the consumer shall bear the costs of appropriate packaging for the return of the defective product or product part.
- h) To be able to make a claim under the Guarantee, the consumer must present the receipt or invoice of the purchase of the product.

## 2. LIMITATIONS OF THE GUARANTEE

- a) The Guarantee applies only to products used for private purposes and not for professional or commercial purposes.
- b) The Guarantee does not apply in the case of normal wear and tear, improper or abusive use, failure to follow the instructions for use, use of the product at the wrong electrical voltage, installation and operation in violation of the applicable electrical regulations, and use of force (e.g. blows).
- c) The Guarantee does not apply if the product has been modified or converted, e.g. conversions from 120 V products to 220-240 V products.
- d) The provision of Guarantee services does not extend the Guarantee period, nor does it initiate the commencement of a new Guarantee period. The Guarantee period for installed spare parts ends with the Guarantee period for the entire product.
- e) **FOR SOUTH-AFRICA & UAE ONLY:**  
Further or other claims, in particular claims for damages, are excluded unless liability is mandatory by law.

After expiry of the Guarantee period or for products for which the Guarantee does not apply, the KitchenAid customer service centres are still available to the end-customer for questions and information.

Further information is also available on our website:

- For U.K. & Ireland [www.kitchenaid.eu](http://www.kitchenaid.eu)
- For South-Africa: [www.kitchenaidafrica.com](http://www.kitchenaidafrica.com)
- For UAE: [www.KitchenAid-MEA.com](http://www.KitchenAid-MEA.com)

# PRODUCT REGISTRATION

---

Register your new KitchenAid appliance now: <http://www.kitchenaid.eu/register>



# **KitchenAid**

©2021 All rights reserved.